

NERCON

ROLCO PRODUCT ACCUMULATORS

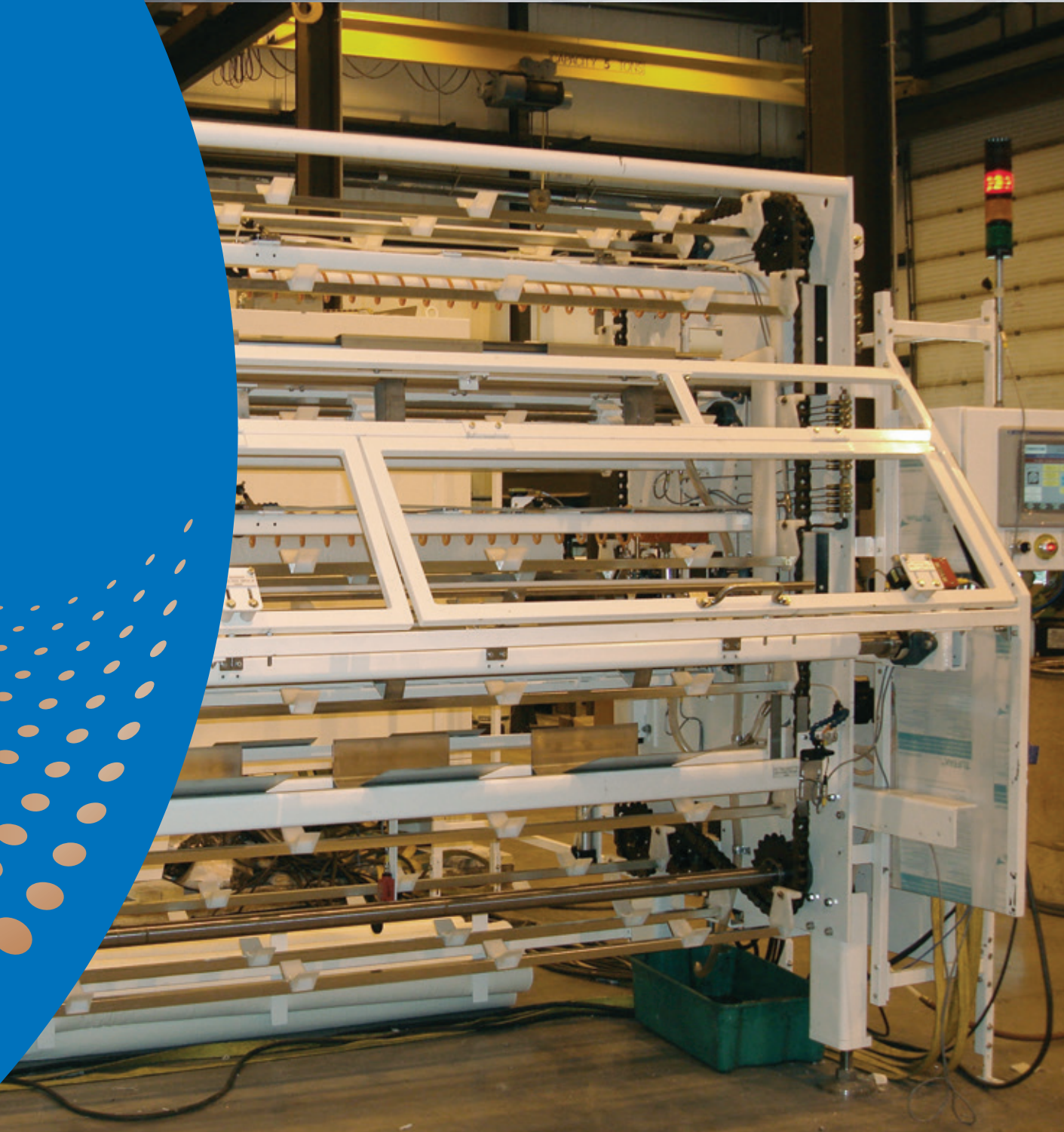

Serpentine Accumulator

First-In/First-Out or First-In/Last-Out

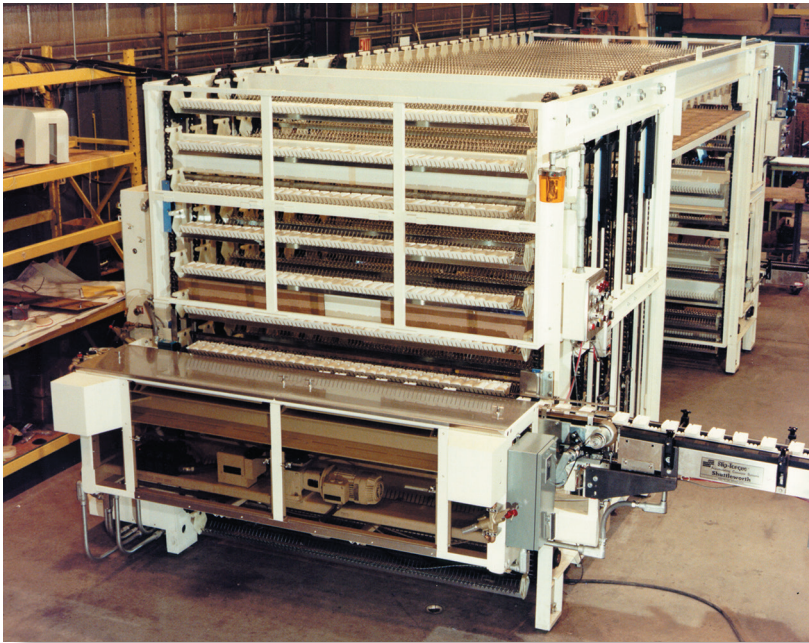

The Soap Bar Accumulator is designed to accumulate soap bars, shaped like a seashell, carried in a cardboard cradle. It operates at rates of 240 bars per minute.

The unique serpentine FIFO (First-In/First-Out) model allows product to be received at any rate, while product is being discharged at the same or at a different rate. After the product is staged on the in-feed conveyor, the in-feed pusher transfers them onto a strip-off deck and retracts to allow the next group of product to be staged. At the same time, a product carrier comes up through the deck, picking up the product and transporting it upward, stopping when the next empty carrier is positioned under the strip-off deck. Product is typically discharged on the opposite side of the machine, where, if downstream equipment is operational, a full carrier will come down through a strip-off deck, depositing the product on top of it. A discharge pusher will transfer it onto the takeaway conveyor. In normal operation, when downstream equipment is operating, the Rolco accumulator works as a conveyor, dispensing

product in the same order as received from the generating unit. Because downstream equipment is usually faster, the accumulated product is gradually pulled out of the accumulator, getting back to a one-for-one with the generating unit. This unit can also be FILO (First-In/Last-Out) where the product is returned to the same conveyor in which it was received.

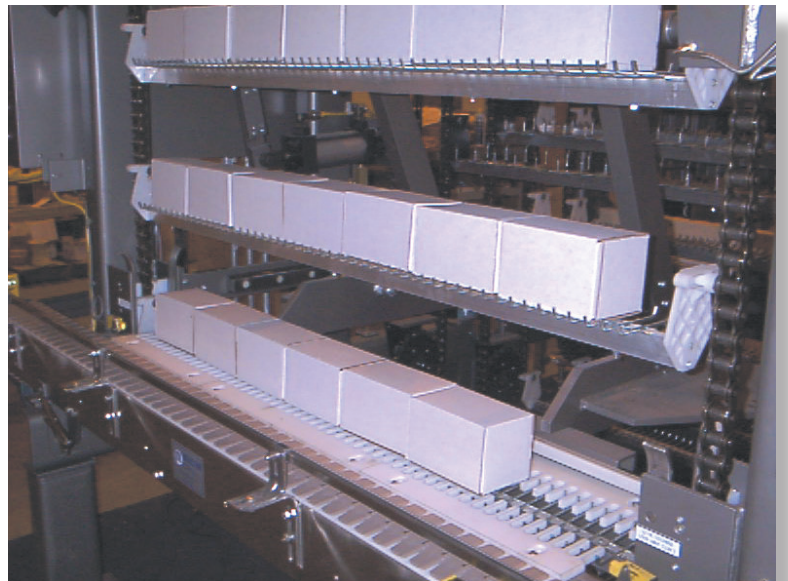

The Strip-Off feature allows the carrier to pass through the deck to pick the product up and set it back onto the deck for discharging. This patented feature allows the product carrier to have high sides and ensures that the product is effectively contained as it is transported through the accumulator.

Serpentine Concept

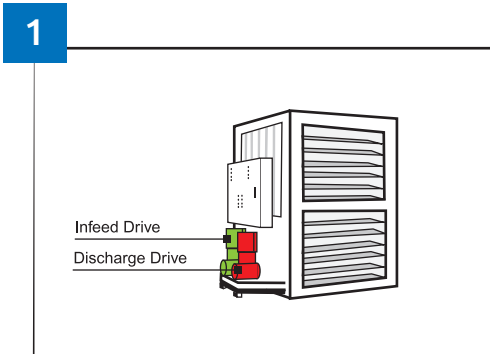

Product carriers are supported on each end by endless chains that can be driven independently at two positions - infeed and discharge.

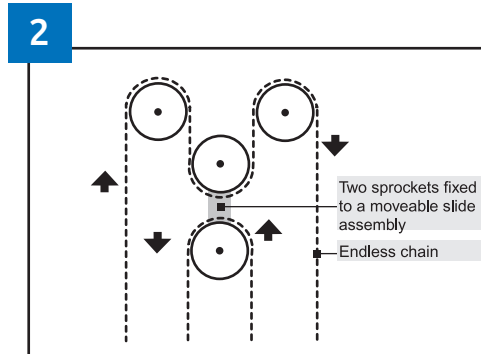

Between the independent infeed and independent discharge, the endless chains follow a path around a series of two separate sprockets fixed to a moveable slide assembly.

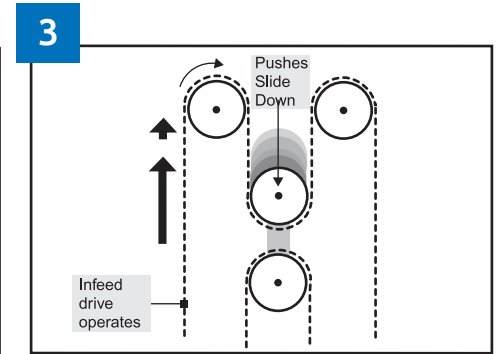

When the infeed drive operates, it pushes the chain upward, creating an excess of chain, which causes the first slide assembly to move downward.

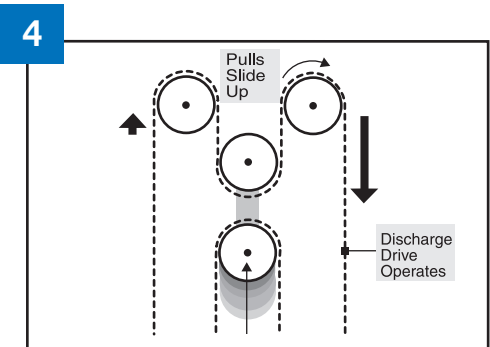

When the discharge drive operates, it pulls this excess chain, causing the slide assembly to move upward.

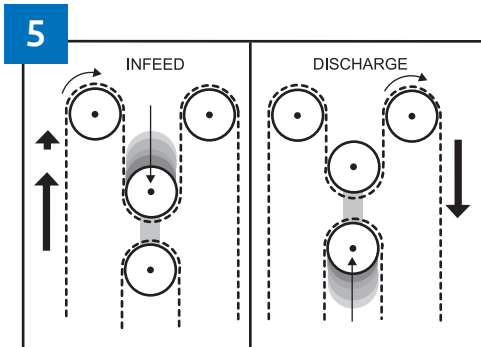

In normal operation, when the generating unit and downstream equipment are running smoothly, the first slide continually moves downward and upward, as the infeed drive provides excess chain and the discharge drive removes it.

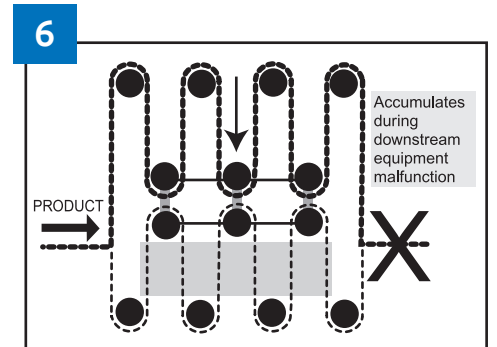

When downstream equipment malfunctions, the Rolco accumulator allows the generating unit to continue operating by storing all of the production within its machine frame. This prevents profit erosion resulting from lost production or labor costs associated with stacking off product.

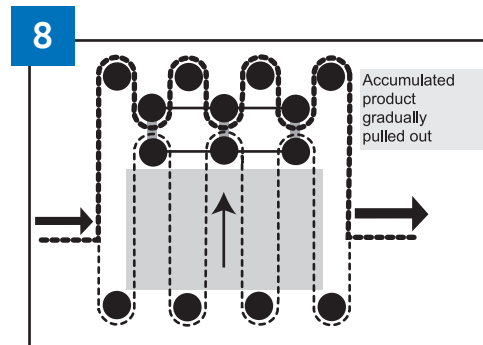
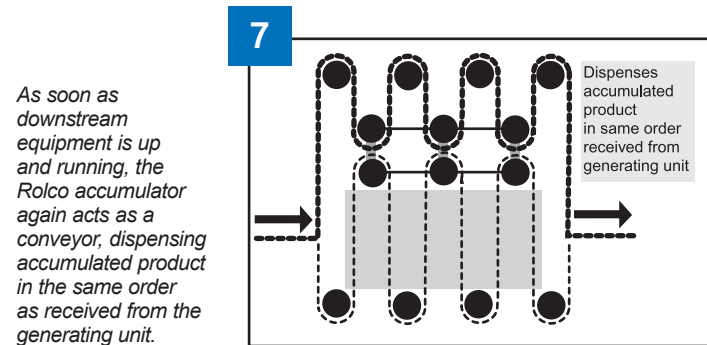

Because downstream equipment is generally faster, the accumulated product is gradually pulled out of the accumulator.

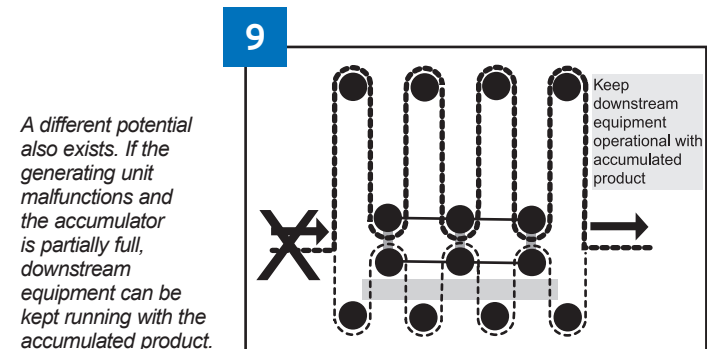

A different potential also exists. If the generating unit malfunctions and the accumulator is partially full, downstream equipment can be kept running with the accumulated product.

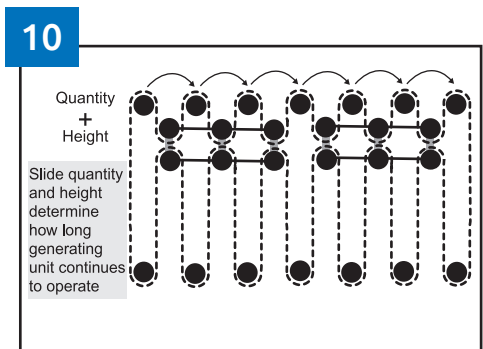

The quantity of slides and the height of each slide determine the accumulator's flexible storage capacity. This in turn determines the period of time the generating unit can continue to operate in the event of downstream equipment malfunction.

Multi-level Storage & Distribution

The Multi-level FIFO (First-In/First-Out) accumulator incorporates multiple levels of wide mat-style conveyors. The multi-level unit is used to store cartons or boxes in the beginning of a production run, or when different products need to be stored for collation. The in-feed loader picks up one row of products and deposits them on the designated layer. The mat-style conveyor cycles one product width forward. This action continues until the layer is full. The accumulator will continue to fill layer by layer until full. The discharge unloader can unload any non-filling layer independent of the in-feed.

Features

- First-In, First-Out method of accumulation ensures sequence of manufacture is maintained, thus enabling effective quality control
- Vertical accumulation maximizes utilization of available floor space
- Product orientation is not disrupted, thereby delivering product more consistently to packaging equipment, which increases the operational reliability of downstream pieces of equipment
- Overall production increases in the range of 5% to 20% can be realized with Rolco Product Accumulators
- Minimal maintenance and simple interface with other equipment
- Changeover from one brand to another is minimal
- Can be used for conditioning different products by installing in a warmer or cooler environment



This Case Accumulation system is also effective when used to condition and age various products ranging from bread and cheese, to frozen dinners.

The continuous loop indexing product carrier deposits a full row of products at any level.

This unit will store 700 - 8000 cases.

Vacuum transfer bar unloads entire row of products onto the continuous loop indexing product carrier.

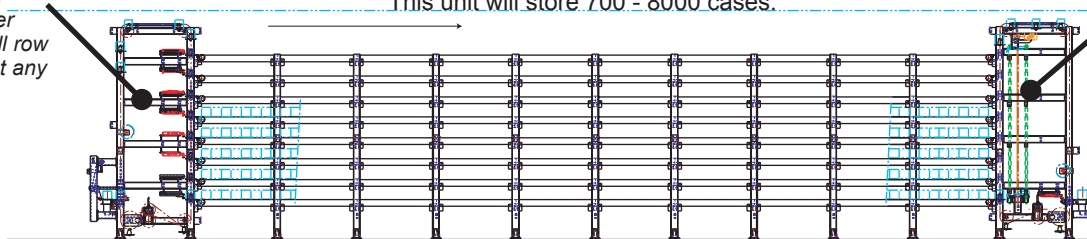

SIDE VIEW

Tail Sealers



Model 15 Tail Sealer

This Model 15 Tail Sealer has a servo-driven traversing glue gun that applies a thin line of adhesive to the inside of the last wrap of a tissue or towel log. The log is then wound up and discharged out the rear of the unit into an accumulator. The finished product has a high quality appearance and provides the consumer with a tab to start unwinding the roll. This unit operates at a rate of 15 logs per minute.

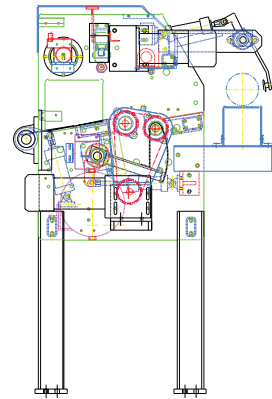

MODEL 15 SIDE VIEW

Product carriers on this Model 30 Tail Sealer transport the tissue or towel logs up to two sealing elevations where a servo-driven traversing glue gun applies a thin line of adhesive to the inside of the last wrap of tissue or towel log. The logs are then wound up and discharged onto the empty product carriers at the rear of the unit and transported down where they are cammed off into an accumulator. This unit operates at a rate of 30 logs per minute.

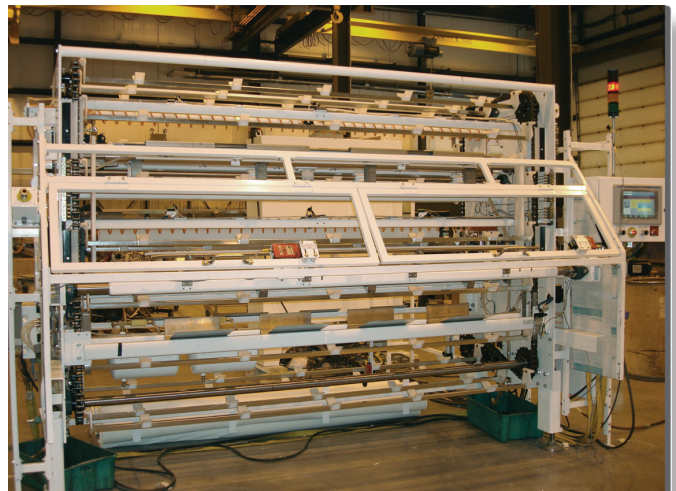

Model 30 Tail Sealer

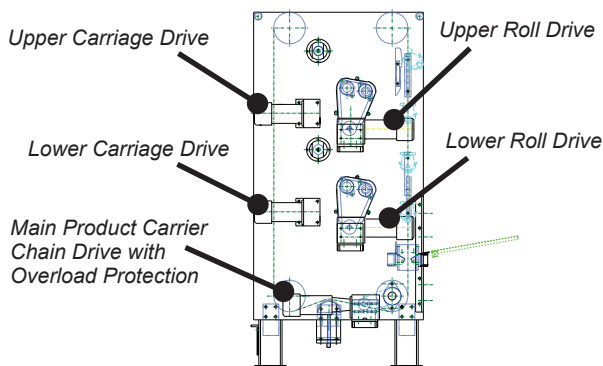

DRIVE SIDE

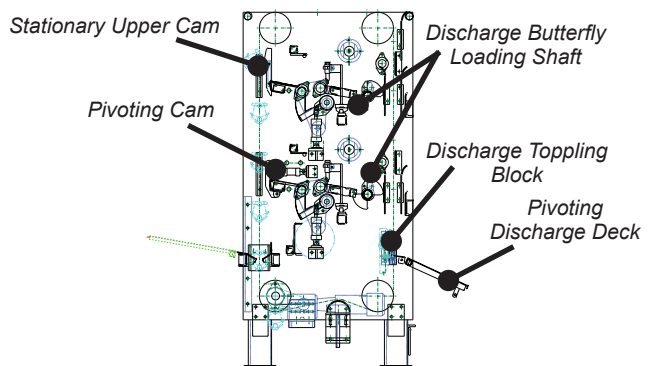

MACHINE CROSS SECTION

Roll & Log Accumulator

The Slit Tissue Roll Accumulation System is designed to accumulate slit bath tissue rolls delivered from two rewinders and discharge them onto any, or all, of four conveyor lanes going to the wrapping operation. Input speed is 220 rolls per minute and discharge speed is 280 rolls per minute.



Roll Accumulator

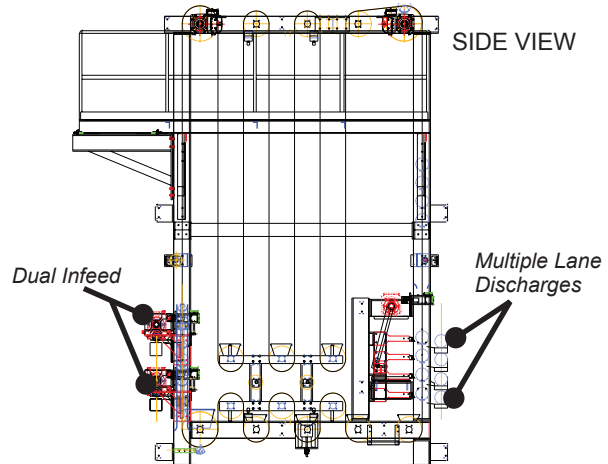

The Log Accumulator is designed to accumulate tissue or towel logs delivered from a reworker. These machines can be designed to maximize resident storage which allows for adhesive drying. They can also be designed to maximize flexible storage which provides log accumulation during downstream malfunctions. The accumulator infeed can utilize a starwheel for transfer from a conveyor, or a direct roll-in design when mating up to a Rolco tail sealer. The accumulator discharge can feed a 2, 3 or 4 lane Rolco log drop discharge system.



Log Accumulator

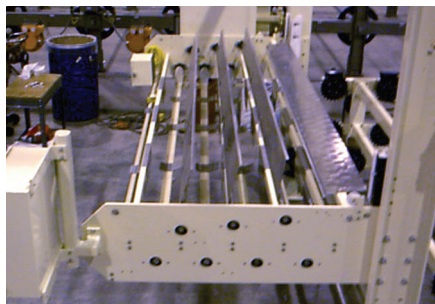
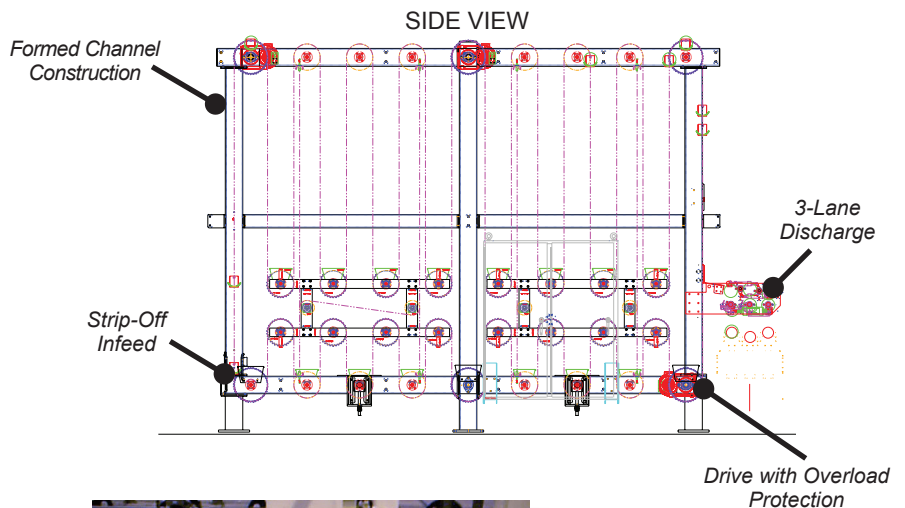

4-Lane Discharge



NERCON

600 S. Commercial St. | Neenah, WI 54956
Toll-Free: 844-293-2814 | FAX: 920-233-3159
www.nerconconveyors.com

